

BOSS[®]
#1 COMPREHENSIVE ELECTRICAL RANGE

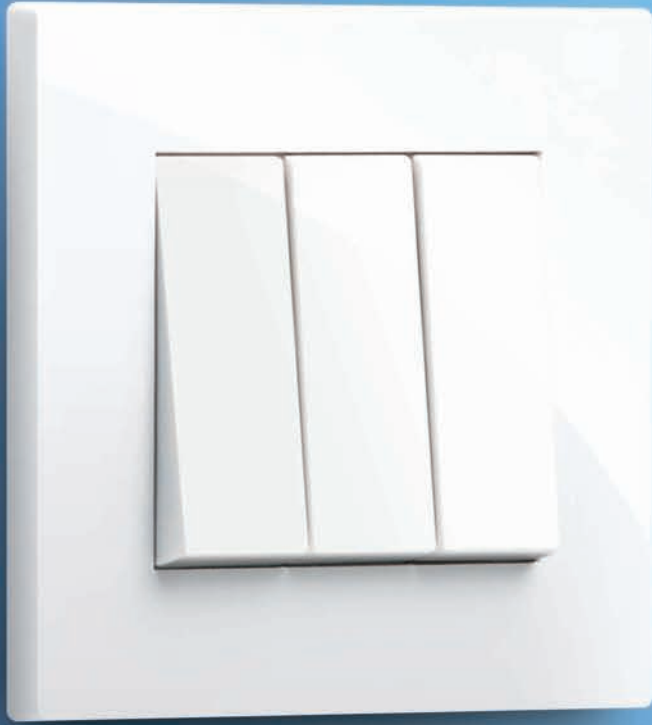

- Made of high impact resistant polycarbonate components.
- Specially designed frame that conceal all mounting screws.
- Multigang Capability.

B1000PURO

CLEAN LOOK AND SIMPLE

B1000 PURO

A slim, trim profile, pleasing to the eye, clean and refined. The B1000 PURO is a switch and socket set that perfectly complements the modern lifestyle.

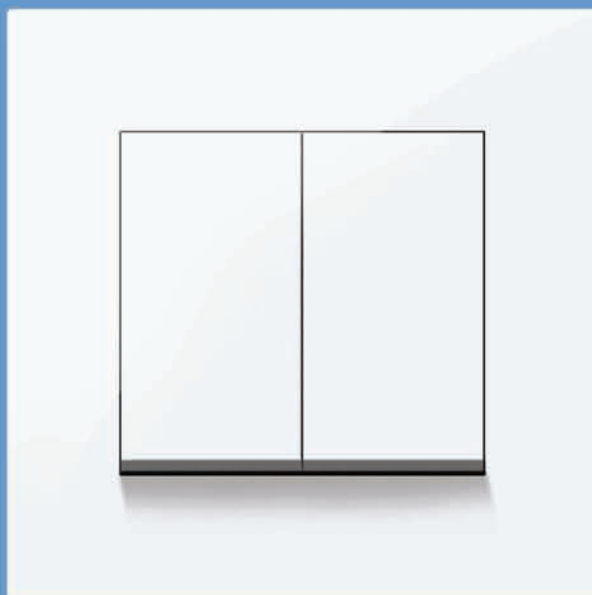

COLOURS CHOICE

BASIC

WE	AD	GM	VI	MY	SY
SG	DM	DS	AP	BG	TQ
LY	BE	LT	DC	SB	PB
BK	GY	NU	MH	BR	BO
YW	GR	BL	RD		



METALLIC

TGD Titanium Gold	DZ Dark Bronze	SV Silver
LD Light Gold	LZ Light Bronze	AN Anthracite
CG Champagne Gold	MZ Metalic Bronze	MBR Metalic Brown

MATTE

SVM Silver Matte
AM Anthracite Matte
MBK Matte Black

HAIRLINE

HSV Hairline Silver	HBK Hairline Black
----------------------------------	---------------------------------



*Minimum quantity may apply. Colour are available upon request.
**The colour shown above are simulated colour. The actual colour may differ.
Please contact our marketing for a colour sample

CLEAN LOOK
& SIMPLE



SWITCHES

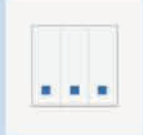

SWITCHES - 10A, AC 250V, BLUE LED INDICATOR

Version	Cat. Num.
1 gang 1 way	B1031/1/2EBA
1 gang 2 way	B1031/2/3EBA
2 gang 1 way	B1032/1/2EBA
2 gang 2 way	B1032/2/3EBA
3 gang 1 way	B1033/1/2EBA
3 gang 2 way	B1033/2/3EBA

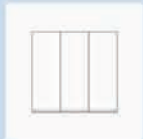

SWITCHES - 10A, AC 250V

Version	Cat. Num.
1 gang 1 way	B1031/1/2A
1 gang 2 way	B1031/2/3A
2 gang 1 way	B1032/1/2A
2 gang 2 way	B1032/2/3A
3 gang 1 way	B1033/1/2A
3 gang 2 way	B1033/2/3A
4 gang 1 way	BT1034/1/2A
4 gang 2 way	BT1034/2/3A
6 gang 1 way	BT1036/1/2A
6 gang 2 way	BT1036/2/3A



INTERMEDIATE SWITCHES - 10A, AC 250V

Version	Cat. Num.
1 gang	B1031IA



BELL SWITCHES

Version	Cat. Num.
w/ bell symbol	B1031BPRA



DIMMER - 500VA

Version	Cat. Num.
1 gang	B1032V500



FAN CONTROL - 400VA

Version	Cat. Num.
1 gang	B1032V400F



BLIND SWITCH - 10A

Version	Cat. Num.
1 gang	B1031BS
2 gang	B1032BS

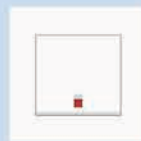

DOUBLE POLE - 20A

Version	Cat. Num.
large switch w/ neon	B1031D20NA
switch w/ neon	B1032D20NA

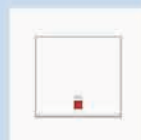

DOUBLE POLE - 45A

Version	Cat. Num.
large switch w/ neon	B1031D45NA

POWER OUTLET



SCHUKO - 16A

Version	Cat. Num.
1 gang	B10426/16S
Twin gang	BT10426/16S



UNIVERSAL - 13A

Version	Cat. Num.
w/o switch & neon	B10413S
w/ switch	B10113LS
w/ switch & neon	B10113LSN
Twin gang	BT10413S



3 ROUND PIN - 15A

Version	Cat. Num.
3 Round Pin	B1015/15
Socket w/switch	

COMMUNICATION OUTLET

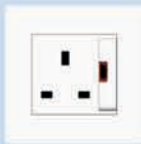

BRITISH STANDARD - 13A

Version	Cat. Num.
w/o switch & neon	B10426
w/ switch	B1015L
w/ switch & neon	B1015LN

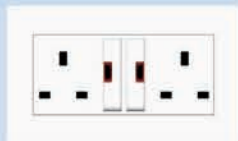
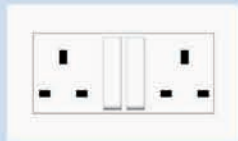
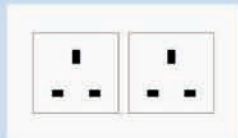

TWIN BRITISH STANDARD - 13A

Version	Cat. Num.
w/o switch & neon	BT10426
w/ switch	BT1025L
w/ switch & neon	BT1025LN



CONNECTION UNIT - 13A

Version	Cat. Num.
with fused	B1030FSG



TELEPHONE - 4 CONTACT

Version	Cat. Num.
1 gang RJ11 Cat3	B1031TO
2 gang RJ11 Cat3	B1032TO



DATA - RJ45, SHUTTERED

Version	Cat. Num.
1 gang Cat5e	B1031CAT5
2 gang Cat5e	B1032CAT5
1 gang Cat6	B1031CAT6
2 gang Cat6	B1032CAT6
1 gang Cat5e +	B1032CAT5/CAT6
1 gang Cat6	



TELP. + DATA - RJ11 4 CONTACT + RJ45

Version	Cat. Num.
1 gang Cat3 +	B1032TO/CAT5
1 gang Cat5e	
1 gang Cat3 +	B1032TO/CAT6
1 gang Cat6	



TV - CO-AXIAL

Version	Cat. Num.
1 gang	B1031TV
2 gang	B1032TV



TVF - F-TYPE

Version	Cat. Num.
1 gang	B1031TVF
2 gang	B1032TVF



TV + TVF - CO-AXIAL + F-TYPE

Version	Cat. Num.
1 gang Co-Axial +	B1032TVSF
1 gang F-Type	



USB - USB CONNECTION

Version	Cat. Num.
1 gang USB	B1031U
2 gang USB	B1032U



USB CHARGER - 5V

Version	Cat. Num.
1 gang 1A	B1031UC
2 gang 1A	B1032UC
1 gang 2,5A	B1031UC25
2 gang 2,5A	B1032UC25



HDMI

Version	Cat. Num.
1 gang	B1031H
2 gang	B1032H



COMBINATION

Version	Cat. Num.
HDMI + USB	B1032HU
HDMI + USB vertical	B1032VHU
HDMI + USB charger 1A	B1032HUC
HDMI + USB charger 2,5A	B1032HUC25
USB + USB charger 1A	B1032UCU
USB + USB charger 2,5A	B1032UC25U



AUDIO VIDEO

Version	Cat. Num.
VGA + Mini Audio	B1032VM
RCA	B1032RCA

HOTEL ACCESSORIES

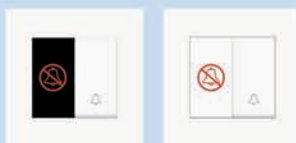

HOTEL - INSIDE ROOM

Version	Cat. Num.
1 gang 2 way switch w/"DND" logo	B1031/2/3A LGD
2 gang 2 way switch w/"DND & MUR" logo	B1032/2/3A LGDM
2 gang 2 way switch w/"DND & MUR" logo (interlock)	B1032/2/3AIL LGDMI
Hotel key card RFID	B1031RFKT
Hotel key card	B1031EKT



HOTEL - CORRIDOR

Version	Cat. Num.
"DND" w/ bell press	B1031BPD
"DND" w/ bell press, white	B1031BPDM
"DND & MUR" w/ bell press	B1031BPWED
"DND & MUR" w/ bell press, White	B1031BPWEDM
"DND & MUR" message indicator	B1030DM

SHAVER UNIT - 110/220V

Version	Cat. Num.
Shaver unit	BT10727
Shaver unit Horizontal	BT10727H

SURROUNDS & BLANK PLATE



COMBINATION

Version	Cat. Num.
2 gang	B1000/2
3 gang	B1000/3
4 gang	B1000/4

COMBINATION

Version	Cat. Num.
2 gang	B1000V2
3 gang	B1000V3



BLANK PLATE

Version	Cat. Num.
1 gang	B1031X
2 gang	BT1031/2X

DESCRIPTION

Alternating Current : 250V

Standard Colour : White (WE)
Material : Polycarbonate
Contents : Complete w/ frame

All Power, Data & Telephone Outlet have Shutter.

DIMENSION

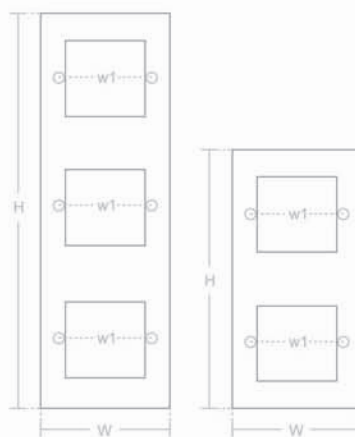
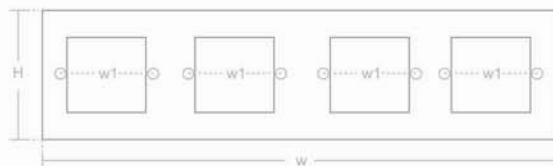
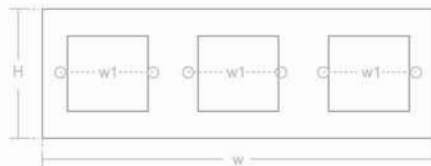
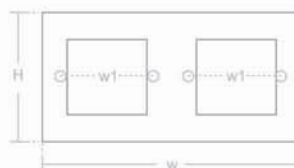
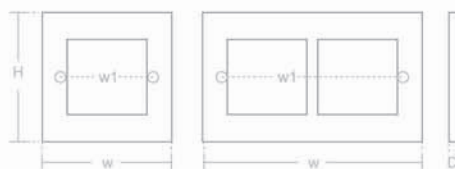

Description	W	H	D	w1
1 gang	86	86	6	60.3
Twin gang	146	86	6	120
2 gang	174	86	6	60.3
3 gang	260	86	6	60.3
4 gang	347	86	6	60.3
2 gang vertical	86	174	6	60.3
3 gang vertical	86	260	6	60.3

SURFACE MOUNTING BOX *

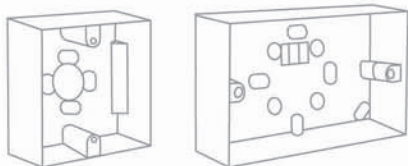

Description	Cat.Num.	W	H	D
1 gang	B238	87	87	35
twin gang	BT238	147	87	35

COLOURS CHOICE

FLUSH MOUNTING BOX



B157P



B157

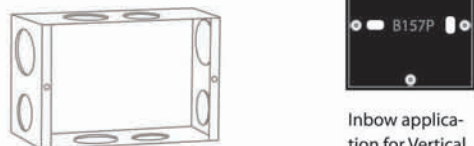

BT157

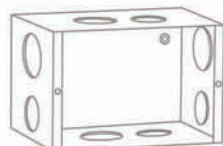

BT157D

Description	Cat.Num.	W	H	D
Plastic - 1 gang	B157P	72	72	40
Metal - 1 gang	B157	72	72	37
Metal - twin gang	BT157	134	72	37
Metal - for shaver	BT157D	134	72	47

Inbow application for Vertical Frame B1000

FLUSH MOUNTING BOX - for dry wall

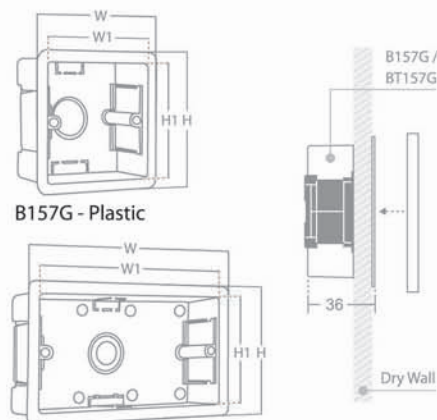

B157G - Plastic

BT157G - Plastic

Description	Cat.Num.	W	H	D	W1	H1
Plastic - 1 gang	B157G	84	84	36	74	74
Plastic - twin gang	BT157G	143	84	36	134	74

WIRING & MECHANISM DIAGRAM

1 way wiring diagram

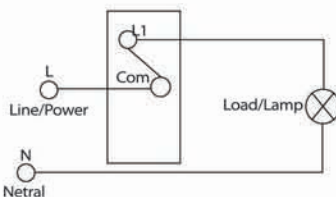

1 way mechanism

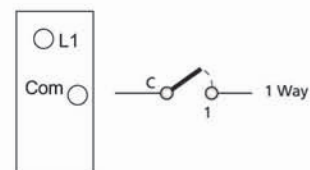

2 way wiring diagram

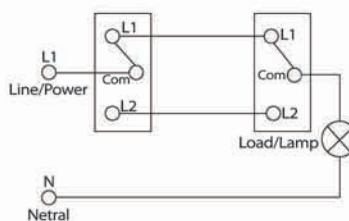

2 way mechanism

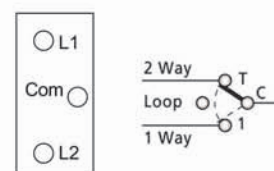

Intermediate wiring diagram

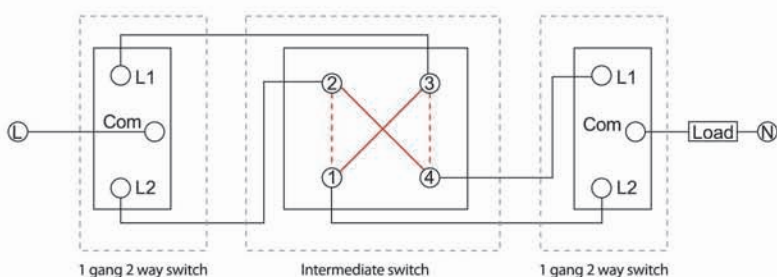

Double pole wiring diagram

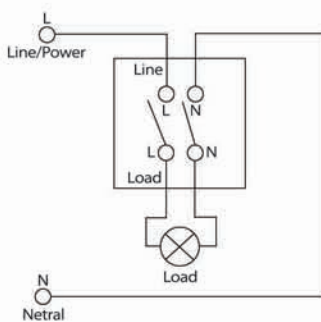

Double pole with neon indicator wiring diagram

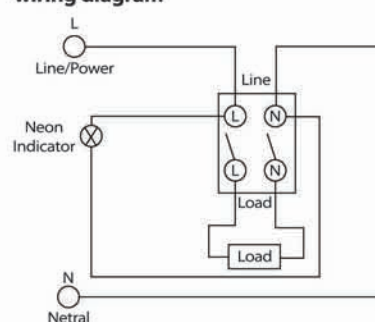

Dimmer & fan control wiring diagram

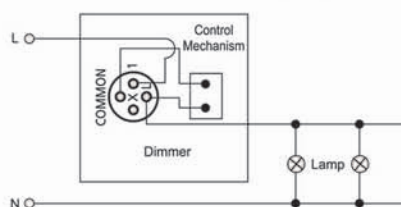

500VA 250V dimmer for incandescent lamps load / 400VA 250V fan control or halogen dimmer switch

BOSS®

#1 COMPREHENSIVE ELECTRICAL RANGE

MS.DI.B1000.01-0318



www.boss.co.id

B1000PURO

CLEAN LOOK AND SIMPLE

AGN
AUSTRALINDO
GRAHA NUSA

SUCOFINDO
PCB 00063102
SNI

SNI 04-3892.1-2006/NRP 119-027-120200